

MESA/BOOGIE

DUAL CALIBER DC-3

Owner's Manual

The Spirit of Art in Technology

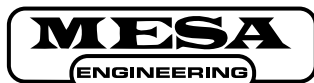

***1317 Ross Street Petaluma, CA 94954
USA***

Hello from the Tone Farm...

YOU, the smart player and all around intuitive human, have put your trust in us to be your amplifier company. This is something we do not take lightly. Our reward is that we've made a classic amplifier and by choosing this amplifier, you have become part of the MESA family...Welcome! Our goal is to never let you down. Your reward is that you are now the owner of an archetypical guitar amp bred of fine all tube amp heritage...benefiting from the many patented pioneering MESA/Boogie circuits that led to the refinement of your new instrument. Feel confident, as we do, this amp will inspire many hours of musical satisfaction and lasting enjoyment. It was built with you in mind, by players who know the value of a fine musical instrument and the commitment it takes to make great music. The same commitment to quality, value and support we make to you...our new friend.

Your MESA/Boogie Amplifier is a professional instrument. Please treat it with respect and operate it properly.

USE COMMON SENSE AND ALWAYS OBSERVE THESE PRECAUTIONS:

- Do not expose amplifier to moisture, rain or water, direct sunlight or extremely high temperatures.
- Always insure that amplifier is properly grounded.
- Always unplug AC power cord before changing fuse or any tubes.
- When replacing fuse, use only same type and rating.
- Avoid direct contact with heated tubes.
- Insure adequate air circulation behind amplifier.
- Keep amplifier away from children.
- Be sure to connect to an AC power supply that meets the power supply specifications listed on the rear of the unit.
- If there is any danger of lightning occurring nearby, remove the power plug from the wall socket in advance.
- To avoid damaging your speakers and other playback equipment, turn off the power of all related equipment before making the connections.
- Do not use excessive force in handling control buttons, switches and controls.
- Remove the power plug from the AC mains socket if the unit is to be stored for an extended period of time.
- Do not use solvents such as benzene or paint thinner to clean the unit. Wipe off the exterior with soft cloth.
- Be sure to have the warranty card for this product filled out by the store at which it was purchased and return to MESA Engineering.

YOUR AMPLIFIER IS LOUD! EXPOSURE TO HIGH SOUND VOLUMES MAY CAUSE PERMANENT HEARING DAMAGE!

No user serviceable parts inside. Refer service to qualified personnel. Always unplug AC power before removing chassis.

EXPORT MODELS: Always insure that unit is wired for proper voltage. Make certain grounding conforms with local standards.

READ AND FOLLOW INSTRUCTIONS OF PROPER USAGE.

DC-3

TABLE OF CONTENTS

	Page #
Precautions _____	0
FRONT PANEL Description and Usage _____	1
Gain _____	2 & 3
Treble _____	3
Mid _____	3
Bass _____	3 & 4
Presence _____	4
Reverb _____	4
Master _____	4 & 5
Output Level _____	5
Graphic EQ _____	5
Toggle Switches: Rhythm / Lead, On / Standby and Power _____	6
REAR PANEL Description and Usage _____	7
Fuse _____	7
EQ Select _____	7
FTSW EQ / Reverb _____	7
FX Loop Send / Return _____	8
FX Mix _____	8
Recording / Silent Recording _____	8
Slave _____	9
Speaker (impedance matching) _____	9
Suggested Sample Settings & Personal Setting Page _____	10 & 11
Tube Task Chart _____	12
Diagnosing Power Tube and Pre-Amp Tube Failures _____	13 & 14
Bias Adjustment: <i>Part of a Continuing Series, by Randall Smith</i> _____	15, 16 & 17
Parts Sheet _____	18

DC-3 Operating Instructions

Overview:

Your DC-3 amplifier was designed to deliver maximum performance in a format based on simplicity. Its easy to dial nature allows each of the two channels to deliver a wide range of sounds in both clean and overdrive styles. This Dual Caliber uses four EL-84 power tubes to fuel its healthy thirty-five watt power section. We are pleased by its surprising headroom, yet truly musical "clipability" when pushed. The DC-3's pre-amp was no afterthought as you may have deduced by the six 12AX7s tucked snugly away under the swing away tube clamp. Two separate sets of tubes are used to accomplish the Rhythm and Lead channels. It's really like having two separate amplifiers built into one chassis. Ultimate flexibility is achieved by providing two complete sets of Tone and Master controls as well as the channel assignable 5 Band Graphic Equalizer. Two different sounds can be switched between without compromising tone or levels.

Looking to the Rear Panel assures that all your interfacing needs are covered. A parallel effects loop with a mix control provides tone insurance for even those questionable effects. A recording circuit dialed for direct to board sessions provides accurate reproduction of the DC-3's pre-amp. When the session goes late into the night, the silent recording Speaker Mute switch comes in real handy. To use the DC-3 in larger rack systems, or to interface to other power sections, the Slave Jack and Level Control are welcome features. Three speaker jacks (one 8 ohm, and two 4 ohm) are provided to ensure the proper impedance match to many types of speaker enclosures. An auto assign EQ rotary control lets you decide whether the 5-Band graphic enhances the Rhythm Channel, the Lead Channel, both, or even allows footswitching of the EQ independently. The Reverb can also be footswitched in or out.

As you can see, the DC-3 provides all the features any demanding pro could need and at the same time remains simple to operate.

FRONT VIEW DC-3

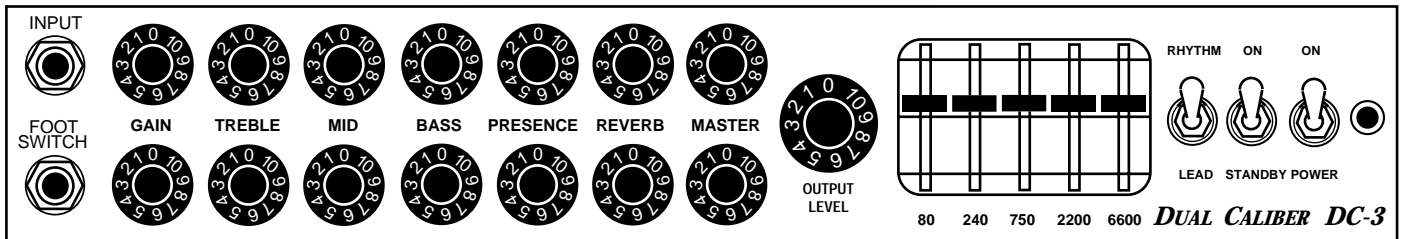

REAR VIEW DC-3

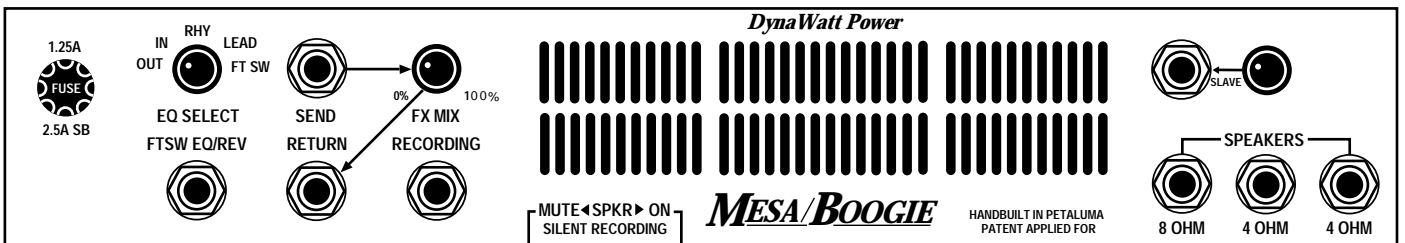

FRONT PANEL:

First familiarize yourself with the layout of the Front Panel and locate the Lead / Rhythm switch on the right side of the chassis, next to the Standby Switch. This toggles you between the top (Rhythm) Channel and the bottom (Lead) Channel. If you don't have the Rhythm/Lead Footswitch connected, this switch will activate the channel switching function. Before we get too critical about each control, let's audition the two channels with a basic clean setting in the Rhythm Channel and a fairly high gain overdriven sound in the Lead Channel.

POWER-UP:

Connect your favorite guitar to the instrument input jack. Turn the power switch "ON" while leaving the standby switch set to "STANDBY". (It's always a good idea to practice this start up procedure as at least 30 seconds of warm-up time lessens the shock on cold power tubes, thus prolonging their life substantially.) Next set the controls and the Graphic EQ per the example below:

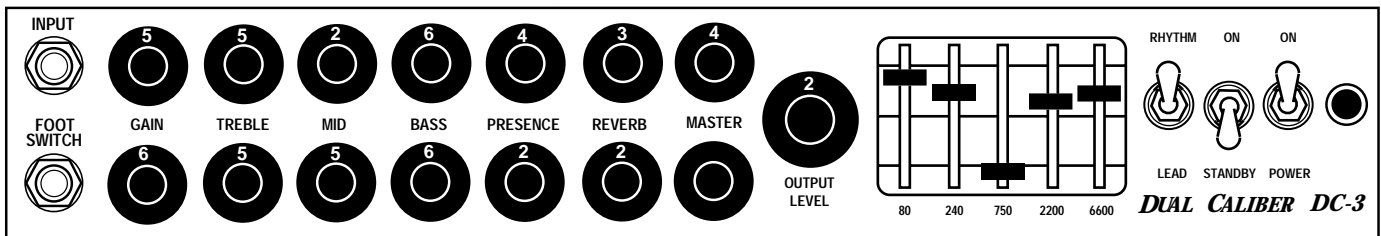

Flip the STANDBY switch to the ON position and listen to the two channels using either the footswitch or the Channel Select toggle switch found on the right side of the Front Panel. The EQ Rotary Control on the left side of the Rear Panel, controls the EQ assignment. This popular "V" type curve works well in both Rhythm and Lead Channels, but most players tend to use it more in the Lead Channel, finding the Rhythm plenty sweet by itself without the use of the EQ. (see page 5 for more information on EQ)

Again, these are merely examples of the two channels. Experimentation leads to finding many different sounds in each channel and understanding the controls and the way they interact, can make this much easier and more fun. Now lets get specific!

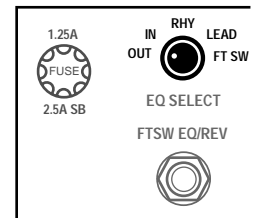

Now that you have heard the DC-3's two channels, let's move on to understanding the controls and their interactive roles in achieving the sounds that you want to hear.

CONTROLS:

GAIN:

This is by far the most powerful control in each channel. It not only determines the overall gain amount, shape and sensitivity of the channel...but it is also a powerful Tone control. Generally speaking, whatever is dialed here ultimately determines the channels personality. Set low, it allows cleaner, brighter sounds with enhanced dynamic response, especially in the higher frequencies. Set high the whole personality of the channel becomes darker, fatter and more overdriven. In the DC-3 we worked hard to make sure the entire range of Gain available is usable and more importantly, musical. Don't think for a moment that this simple one knob layout limits you as to the amount and texture of gain. Long neurotic hours were spent to ensure the ranges of gain were stylistically accurate. It's

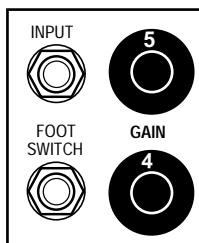

GAIN: (Continued)

probably a good time to mention that most of the great sounds can be found by setting the GAIN Control moderately, especially in the LEAD Channel. For example, somewhere between **2** thru **6**. In the RHYTHM Channel try setting this control somewhere between **3** thru **8**. Use of moderation here will reduce the likelihood of pesky tube microphonic problems ever occurring, while at the same time making the two channels easier to balance in relative listening volume and effects send signal strength.

TREBLE:

As with most guitar amplifiers, the TREBLE Control is the strongest of the three rotary tone controls. It controls the blend of high frequencies in a wide band between the midrange and presence frequency ranges. Its setting on the DC-3 also determines the blend and strength of the MIDDLE and BASS Controls. Set high, it is the dominant control, minimizing the amount of MID and BASS that would be possible in the mix. Set low, the TREBLE becomes the recessive control and a warmer, darker blend is produced. Dial with care. Subtle tweaking of this control tends to produce the best results.

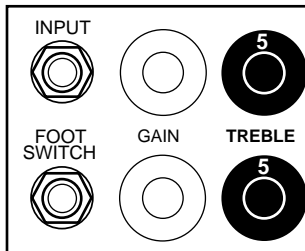

MIDRANGE

Your new Dual Caliber uses a unique Midrange Circuit that not only blends in rich warm midrange, but goes beyond to give you an added bonus. Through endless daily tone dreaming, the “if-only” design dictum led to the dial-in-gain boost. In the DC-3 a third over the top crunch sound was made possible by the inclusion of the RHYTHM Channels dual purpose MID Control.

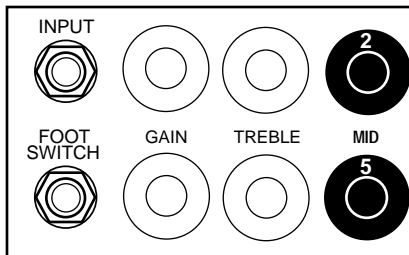

From **0** to about **3** the taper is adjusted to act as a very effective MID Control. As you increase the MID to **4** and above, you will hear the lower Mids getting more pronounced and fatter. At about **6** the MID leaves behind the old notion of being a tone control and becomes a truly usable gain control. This upper range is a smokin' addition to the RHYTHM Channel's GAIN Control for all kinds of higher gain rhythm sounds. Try the MID Control set high and the GAIN Control at about **6** - **7** for a cool blues solo sound. If

this still isn't crazy enough for you...Max the GAIN and TREBLE Controls and set the PRESENCE Control to **0** or **1**, turn on the Graphic and give it the old “V” curve and plug into a 4x12 with some Celestion Vintage 30's or 25's. This should be sufficiently heinous for even the sickest crunch fiends. As you can see, the versatility that this dual purpose MID Control lends to the Rhythm Channel greatly expands its usefulness as both a clean and overdrive channel.

NOTE: The lower region of the MID Control determines midrange punch and boldness in lower gain sounds and a smooth vocal blend in high gain sounds. It can be very effective acting as a “cut through the band control” in certain situations. Dial to taste, remembering that the setting of the TREBLE Control greatly effects this controls strength.

BASS:

This control blends in the lower frequencies and its effectiveness, again, depends on the setting of the TREBLE Control. It should be set with moderation as extreme settings in either low or high directions can produce an unbalanced tone. Be “especially” careful in higher Gain settings of either channel. Too much Bass will cause a flabby unfocused sound that can't be dialed out with the graphic EQ because excessive Bass has been introduced to the pre-amp in the early stages. Try setting the BASS to **6** for clean sounds in the RHYTHM Channel and **4** or below when dialing up high gain overdriven

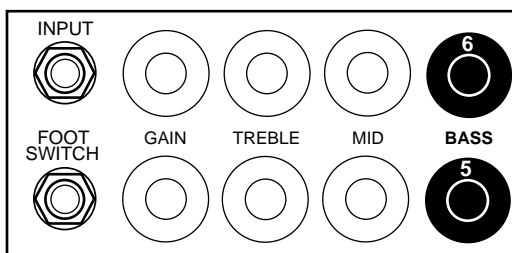

BASS: (Continued)

sounds in this channel. In the LEAD Channel, try setting the BASS Control somewhere between **3** and **6**. These settings will vary with the amount of Gain and Treble you have dialed up.

PRESENCE:

These two controls attenuate the upper high end harmonics and control dynamic compression in the power section. High settings produce more sparkle and cut, lending a more open quality to the Channel. Low settings of the PRESENCE Control compress the sound and enhance the more vocal qualities of single notes.

This control can also produce a fatter, warmer character, especially in the LEAD Channel. Lower Treble settings, combined with low PRESENCE Control settings produce the richest, roundest lead sounds. Try setting the RHYTHM Channels' PRESENCE Control at around **5** or **6** for the sweet blend of sparkle and cut. This range in the RHYTHM Channel also tends to give the impression of more headroom. Try a LEAD Channel PRESENCE Control setting of **3** to start with and adjust to taste. Avoid setting the LEAD PRESENCE Control to **10** when high Gain and Treble settings are in use. This reduces the likelihood of annoying microphonic tube problems.

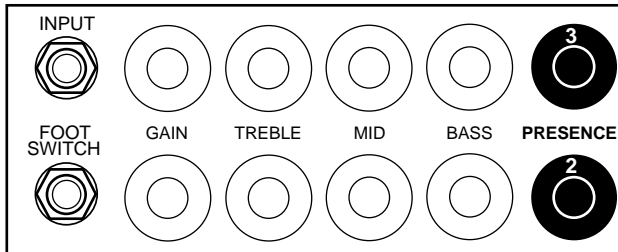

REVERB:

The DC-3 has an individual REVERB Control per channel. This enables different amounts of the rich ALL TUBE reverb to be mixed with the dry signal of each channel. It is normal for extreme settings of the REVERB Control to slightly alter the character of the channel as the voicing of the reverb circuit becomes more dominant in the mix.

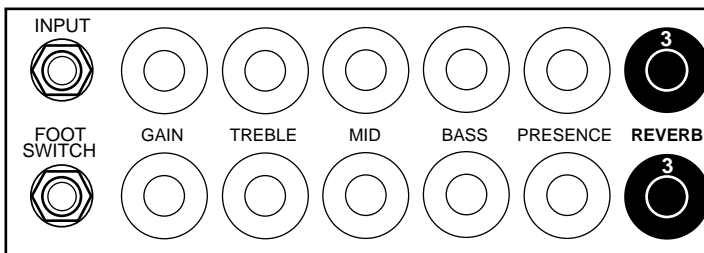

MASTER:

The individual channel MASTER Controls serve three purposes in the layout of the DC-3. FIRST: They serve as level balancing controls for each of the two channels. This enables a wide range of front end gain settings to be matched to a given listening level and the level of the other channel. SECOND: They act as effects send controls, for each channel, in the effects loop. As with many of the controls on the DC-3, the best results for balance and tone are usually found in the medium range of this control. THIRD: The MASTER Control is the Recording jacks' send level control.

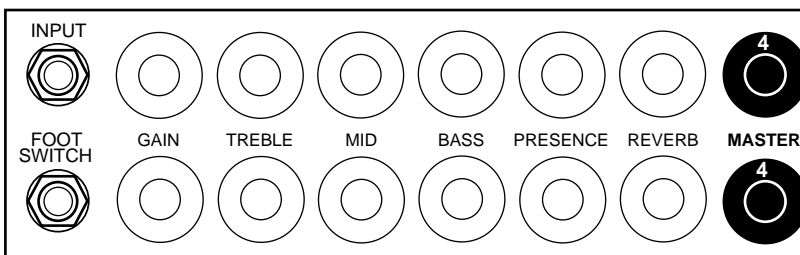

When using the direct Recording jack found on the Rear Panel to interface directly to a mixing board or recorder, this control will determine the amount of signal you will be sending via this jack. In this application it is usually best to start with the MASTER Controls set to **0** and gradually increase them to the proper level. This minimizes the possibility of blowing speakers or eardrums in the event the engineer has an extremely sensitive input headroom setting in place at the console.

MASTER: (Continued)

NOTE: When trying to use your DC-3 at extremely low volume levels it will be necessary to reduce the far left Gain control. Once the Masters and Output Levels has been reduced to roughly 1.5 , reducing the Masters or Output Level below this point causes phase interaction that prevents a clean signal from passing through this circuit junction. If you must use your DC-3 at whisper levels to practice late at night etc...get used to reducing the Gain as well as the Masters and Output levels. This effect is most noticeable in the Rhythm channel set for a crystal clean sound. In the Lead channel set for a high gain sound the interaction effect is greatly reduced and virtually unnoticeable.

OUTPUT LEVEL:

This lonely knob is the DC-3's final Output knob or overall master. After the relative balance of the two channels has been set with the channel MASTER Controls, use this OUTPUT LEVEL Control to increase or decrease the listening volume. It is also the Effects

Return Level control, a point we thought you should know. This design element makes setting up a lot easier and gives you one less knob to deal with when interfacing to your favorite effects. Optimum setting depends on the size of the room you wish to rock, but generally the DC-3 sounds best with a setting somewhere between **2** and **6** on the OUTPUT LEVEL Control.

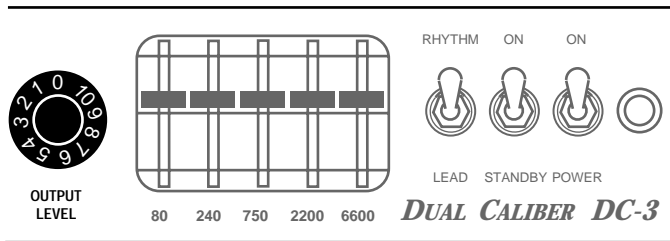

GRAPHIC EQ:

The five band graphic provides limitless additional shaping of the already curvacious tone. It is bypassable and channel assignable. It is also footswitchable manually via the stereo 1/4 inch jack located on the Rear Panel. These assignment choices are menued on the Rear Panel around the rotary control that is used to choose each position. The five choices are: "OUT" all the time (bypassed), "IN" all the time (engaged), "IN" on the Rhythm Channel, "IN" on the Lead Channel and "Footswitchable." The Graphic is not a necessity to amazing tone, but can greatly enlarge the scope of sonic possibilities through experimentation. If you never turned it on you would still have one of the most amazing sounding amps around...but it's there...so you may as well take a crack at some tweaking. One setting that keeps popping up as a classic Boogie EQ curve is the fabled "V". This setting increases the bottom, scoops the mids and leaves the highs to do their harmonic best. Be sure to try this at some point as many Boogie users have found it to be their main sound with its huge wideness and spread. Below are some sample settings that we see used quite often, but by all means experiment.

1. The fabled "V" shape

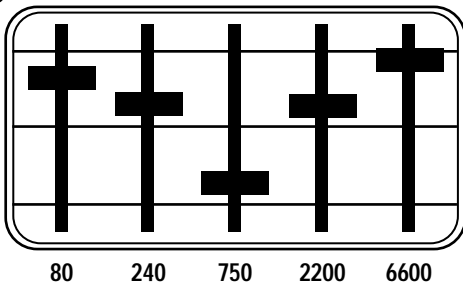

2.

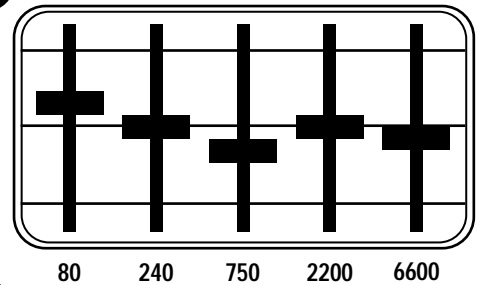

3.

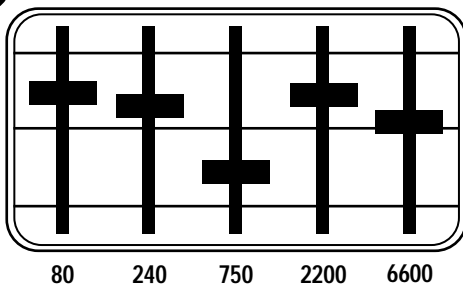

4.

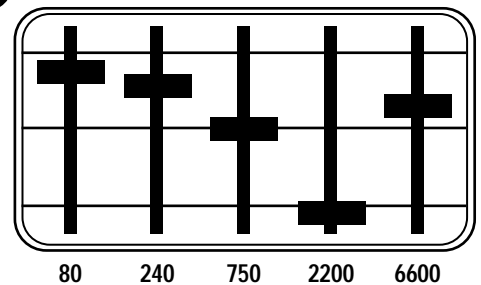

TOGGLE SWITCHES

RHYTHM / LEAD:

This toggle calls up one channel or the other and can take the place of the Channel Select footswitch when there isn't one handy.

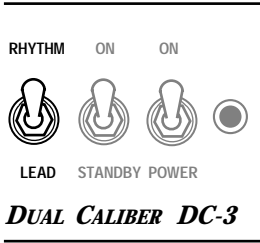

ON / STANDBY:

Perfect for set breaks... this toggle switch also serves an even more important purpose. In the Standby position the tubes are at idle so that during power up they may warm up before being put to use. Before Power is switched on make sure the STANDBY switch is in the Standby position. Wait at least 30 seconds and then flip the STANDBY switch to the "ON" position. This prevents tube problems and increases their toneful life substantially.

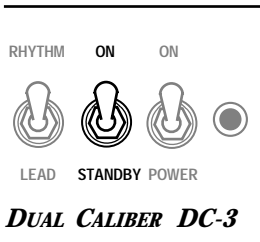

POWER:

This switch delivers the A.C. power to the DC-3. Make sure the unit is grounded (All three terminals of the A.C. cord must be connected whenever possible to avoid injury to the user as well as to the unit) and that the proper voltage is present. Follow the cold start procedure described in the above section ON / STANDBY when powering up your DC-3.

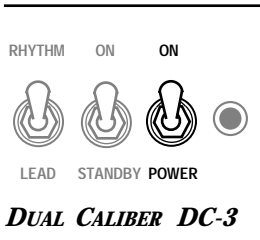

REST AREA

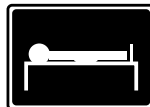

REAR PANEL:

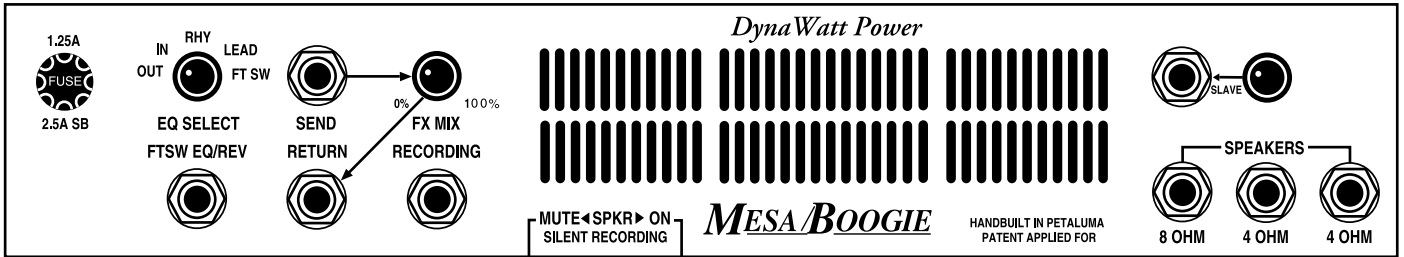

FUSE:

This is the A.C.'s (Alternating Current) main fuse and provides electrical current protection from outside A.C. fluctuations, as well as power tube failure damage. Should the FUSE blow, replace it with the same rating in a slo-blo type package. The domestic U.S. version requires a 2.5 amp slo-blo fuse. A power tube short or failure is often the cause of a blown fuse...Follow the cold start procedure mentioned in the ON/STANDBY switch section and watch the four EL-84 power tubes as you flip the STANDBY switch to the ON position. If a power tube is going bad or is arcing you will see it! Flip the STANDBY switch to Standby immediately and replace the faulty power tube and the FUSE if necessary. If you see nothing abnormal as you lift the STANDBY switch, it is possible that a power tube shorted temporarily and blew the FUSE. If this is the case it may work again normally. To be extra safe you may want to replace all four power tubes in the "shotgun" troubleshooting tradition and save the replaced set as spares.

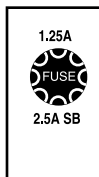

NOTE: Like tires on a car, spare tubes are always a measure of good insurance. Your DC-3 was carefully constructed with reliability in mind! Given the proper care and maintenance, it will deliver years of trouble free service. However, any pro guitarist who is out there gigging will tell you; spare tubes are a must for the fabled cord bag and may someday be worth their weight in gold. Spare fuses are also a very easy way to insure an uninterrupted performance.

EQ SELECT:

As we mentioned earlier in the Graphic EQ section, this rotary control is used to select the assignment of the 5 assignment of the 5-Band Equalizer. See Graphic EQ section on page 5 for an explanation of the 5 possible positions of this rotary control.

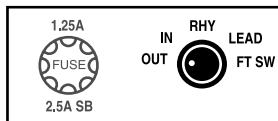

FTSW EQ/REV:

This 1/4" Stereo jack allows you control of the EQ and Reverb remotely when a Stereo cable and Mesa Dual Footswitch are connected. This footswitch is an option and can be ordered by calling us direct, or by contacting your nearest Mesa/ Boogie Pro Center.

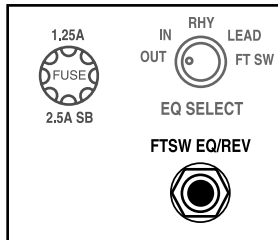

REAR PANEL: (Continued)

FX LOOP: SEND / RETURN:

These two 1/4" jacks are the patch point for external effects. The Effects Loop is wired in parallel with the normal signal. Connect the SEND jack to your Effects Input jack. Connect the RETURN jack to the Output jack of your effect. The Effects Loop is a patch point between the pre-amp and power section. Therefore, the RETURN jack can double as a "Power Amp Input" jack.

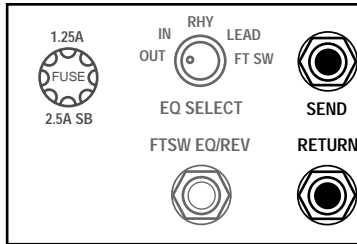

When the RETURN jack is used as an input, only the 5 Band EQ, the PRESENCE control of the active channel and the OUTPUT LEVEL control are being utilized, all other controls are inactive.

FX MIX:

This control determines the dry/wet blend of the FX Loop signal in relation to the unaffected signal. Set to 0% you will experience only the dry signal (no effect) and at a setting of 100% the entire signal will be wet (total effect.)

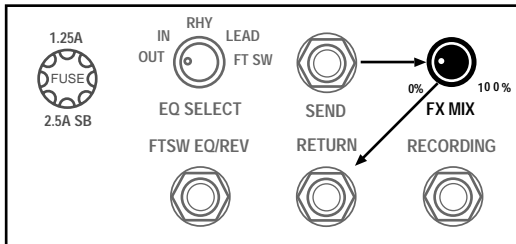

For the best results...Set the mix of your effect to 100% wet. Then dial in the amount of effect that you wish to hear, starting at 0% with the FX Loop Mix Control. The drier (closer to 0%) signal you use, the better your tone should be. This is one of the advantages in having a parallel type FX Loop designed into your DC-3 amplifier...this circuit allows the amplifier to retain its purity with the least possible degradation due to effects impedance mismatching.

RECORDING:

This jack provides direct-to-console interfacing for recording or sound reinforcement applications. It is a circuit dedicated to reproducing the roll off that occurs in the output section with a speaker connected. With accuracy, it faithfully captures the DC-3's soulful character.

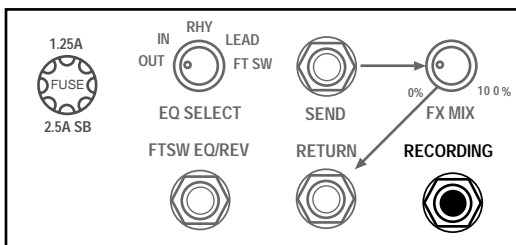

The send level strength is determined by the GAIN and MASTER Controls. From the Recording jack, adequate signal level will be available for most of your recording needs and live performances.

SILENT RECORDING:

This rocker switch which is located down under the chassis and selects between the live "Speaker On" setting and the silent "Speaker Mute" setting. This is a perfect solution for all-nighters! This switch mutes all of the signal at the power section driver stage, removing the need for a speaker load IN THIS POSITION ONLY!

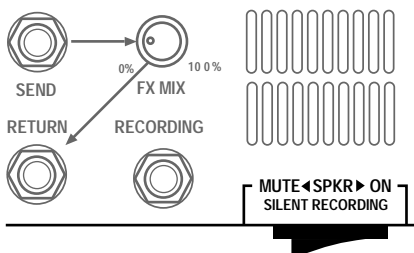

NOTE: When this switch is set to the "ON" position, a speaker load must be maintained by either a load resistor of some type or a speaker itself. Failure to comply with this instruction could result in major damage to the amplifier. Leave your speaker connected.

REAR PANEL: (continued)

SLAVE:

This 1/4" jack and control provide a signal derived from the speaker jack. Perfect for using the DC-3 as a master pre-amp, or additional power amps may be connected for more power when needed. Some players use this to derive an FX Send Signal and go to other amps for their wet sound.

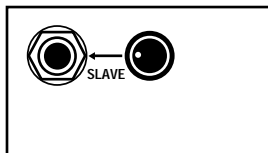

NOTE: Once a signal is taken from the SLAVE it can not be inserted back into the FX Loop Return jack or a feedback loop will occur. Much like holding a microphone into the PA system's cabinets...a loud high pitched squeal will result.

SPEAKERS:

One 8 ohm and two 4 ohm speaker jacks are provided. The DC-3 is not overly sensitive to speaker mismatches and will not be damaged by them, except that very low ohmage loads will cause the power tubes to wear faster. A single twelve-inch 8 ohm speaker should generally be connected to the 8 ohm output. When using two 8 ohm speakers, connect them both to the 4 ohm outputs provided (because the total load is 4 ohms in that case.)

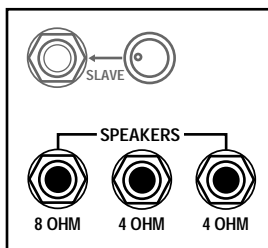

4X12 cabinets may be 4, 8 or 16 ohms; if you are not sure of the impedance of your cabinet, you may need to remove the rear panel to see what the ohmage of the individual speakers are. Mesa/Boogie 4X12 cabinets come standard wired to 8 ohms. They have four 8 ohm speakers wired in series-parallel. Some Non-Mesa 4X12 cabinets are wired 16 ohms using four 16 ohm speakers. By wiring all four speakers in parallel, you can reduce the cabinet to an impedance load of 4 ohms (assuming the speakers are 16 ohms each.) No matter how unusual your speaker setup, it is always possible to get good

performance. If you need two 8 ohm speaker jacks (in order to run two 16 ohm cabinets at the same time), you can use a Y-box and daisy-chain the cabinets together.

Feel free to experiment with the speaker jacks, trying different loads. Many great sounds and feels may be achieved by experimenting with different combinations of speaker impedance. Keep in mind the greatest clean headroom is always achieved with proper impedance loads...i.e. an 8 ohm speaker connected to an 8 ohm jack.

NOTE: Always use a load on the DC-3 when playing, unless you are recording direct and have the silent recording switch set to the Mute position.

SUGGESTED SAMPLE SETTINGS

SAMPLE 1 Sparkling Clean

CHANNEL Rhythm

INPUT: 5, 5, 1, 4, 2, 2, 4

FOOT SWITCH: (empty)

GAIN: 5, TREBLE: 5, MID: 1, BASS: 4, PRESENCE: 2, REVERB: 2, MASTER: 4

OUTPUT LEVEL: 3

EQ: 80, 240, 750, 2200, 6600

RHYTHM: ON, ON, ON

LEAD, STANDBY, POWER

DUAL CALIBER DC-3

SAMPLE 2 Pushed Bluesy Rhythm/Solo

CHANNEL Rhythm

INPUT: 8, 7, 7, 2, 0, 3, 4

FOOT SWITCH: (empty)

GAIN: 8, TREBLE: 7, MID: 7, BASS: 2, PRESENCE: 0, REVERB: 3, MASTER: 4

OUTPUT LEVEL: 2

EQ: 80, 240, 750, 2200, 6600

RHYTHM: ON, ON, ON

LEAD, STANDBY, POWER

DUAL CALIBER DC-3

SAMPLE 3 Crunch Rhythm

EQ Optional

CHANNEL Rhythm

INPUT: 9, 7, 6, 3, 0, 0, 3

FOOT SWITCH: (empty)

GAIN: 9, TREBLE: 7, MID: 6, BASS: 3, PRESENCE: 0, REVERB: 0, MASTER: 3

OUTPUT LEVEL: 2

EQ: 80, 240, 750, 2200, 6600

RHYTHM: ON, ON, ON

LEAD, STANDBY, POWER

DUAL CALIBER DC-3

SAMPLE 4 High Gain Lead/Crunch

EQ Optional

CHANNEL Lead

INPUT: (empty)

FOOT SWITCH: (empty)

GAIN: (empty), TREBLE: (empty), MID: (empty), BASS: (empty), PRESENCE: (empty), REVERB: (empty), MASTER: (empty)

OUTPUT LEVEL: 3

EQ: 80, 240, 750, 2200, 6600

RHYTHM: (empty), ON, ON







LEAD, STANDBY, POWER

DUAL CALIBER DC-3

PERSONAL SETTINGS PAGE

INPUT





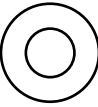



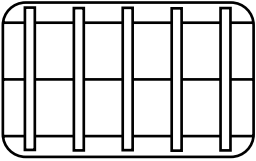







OUTPUT LEVEL



RHYTHM ON ON

FOOT SWITCH



GAIN

TREBLE

MID

BASS

PRESENCE

REVERB

MASTER

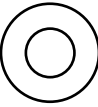

OUTPUT LEVEL

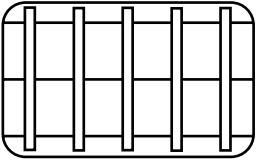

LEAD STANDBY POWER

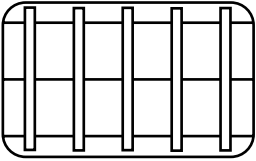







80 240 750 2200 6600

DUAL CALIBER DC-3

INPUT





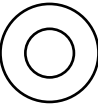



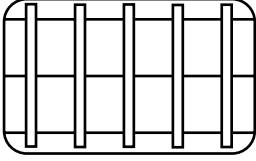







OUTPUT LEVEL



RHYTHM ON ON

FOOT SWITCH



GAIN

TREBLE

MID

BASS

PRESENCE

REVERB

MASTER

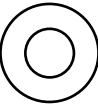

OUTPUT LEVEL

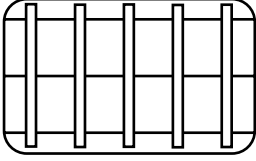

LEAD STANDBY POWER

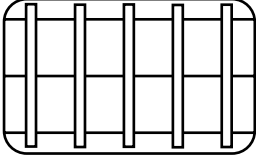







80 240 750 2200 6600

DUAL CALIBER DC-3

INPUT





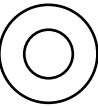



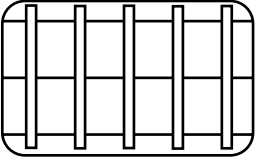







OUTPUT LEVEL



RHYTHM ON ON

FOOT SWITCH



GAIN

TREBLE

MID

BASS

PRESENCE

REVERB

MASTER

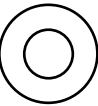

OUTPUT LEVEL

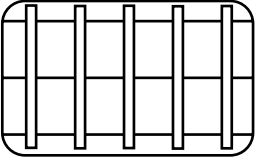

LEAD STANDBY POWER

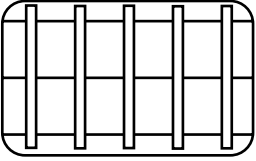







80 240 750 2200 6600

DUAL CALIBER DC-3

INPUT





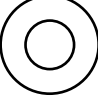



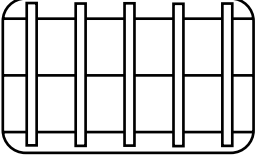







OUTPUT LEVEL



RHYTHM ON ON

FOOT SWITCH



GAIN

TREBLE

MID

BASS

PRESENCE

REVERB

MASTER

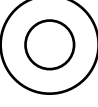

OUTPUT LEVEL

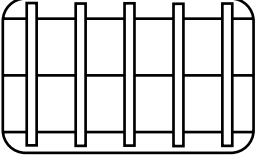

LEAD STANDBY POWER

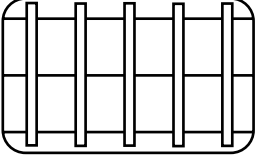

80 240 750 2200 6600

DUAL CALIBER DC-3

Partial View Of Chassis

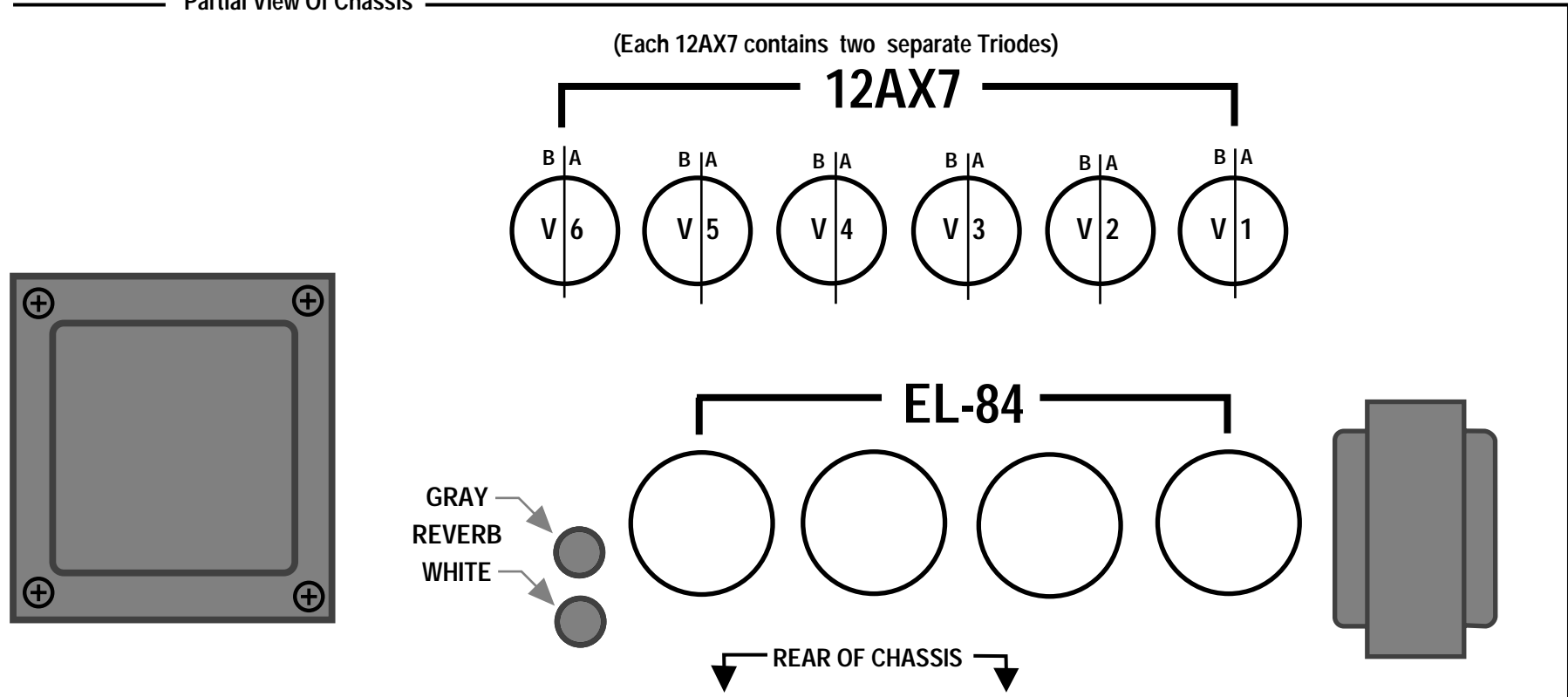

Description of Tube Functions

V1A= First Rhythm
 V1B= First Lead
 V2A= Second Lead
 V2B= Third Lead
 V3A= Fourth Lead
 V3B= FX Return

V4A= Third Rhythm
 V4B= Second Rhythm
 V5A= Reverb Send
 V5B= Reverb Return
 V6A= >
 V6B= > Phase Splitter / Driver

TUBE NOISE & MICROPHONICS

You may occasionally experience some form of tube noise or microphonics. Certainly no cause for alarm, this quirky behavior comes with the territory and the Tone. Much like changing a light bulb, you don't need a technician to cure these types of minor user serviceable annoyances and in fact, you'll be amazed at how easy it is to cure tube problems...by simply swapping out a pre-amp or power tube!

First may we suggest that you set the amplifier up on something so that you can get to the tubes comfortably without having to bend down. It also helps to have adequate lighting as you will need to see the tube sockets clearly to swap tubes. Use caution and common sense when touching the tubes after the amplifier has been on as they may be extremely hot! If they are hot and you don't want to wait for them to cool off, try grasping them with a rag and also note that the glass down around the bulbous silvery tip is considerably less hot which makes it easier to handle. Gently rock the tube back and forth as you pull it away from its socket.

DIAGNOSING POWER TUBE FAILURES:

There are two main types of tube faults: shorts and noise. Both large and small tubes may fall prey to either of these problems but diagnosis and remedy is usually simple.

If a fuse blows, the problem is most likely a shorted power tube and shorts can either be mild or severe. In a mildly shorted tube the electron flow has overcome the control grid and excess current flows to the plate. You will usually hear the amp become distorted and begin to hum slightly. If this occurs, quickly look at the power tubes as you switch the amp to STANDBY and try to identify one as glowing red hot. It is likely that two of a pair will be glowing since the "shorted" tube will pull down the bias for its adjacent mates, but one tube may be glowing hotter — and that one is the culprit. The other two are often fine — unless they've been glowing bright red for several minutes.

Because there is no physical short inside the tube (just electrons rioting out of control) merely switching to STANDBY for a few moments then back to ON will usually cure the problem...at least temporarily. Watch the tubes carefully now. Should the problem recur, the intermittent tube will visibly start to over heat before the others and thus it can be identified. It should be replaced with one from the same color batch, shown on its label. Call us and we will send one out to you. The severe short is not nearly so benign. In the worst cases, a major arcing short occurs between the plate and the cathode with visible lightning inside the glass and a major noise through the speaker. If this is seen to happen, IMMEDIATELY turn the amp to STANDBY. By this time the fuse probably will have blown. Such a short is usually caused by a physical breakdown inside the tube including contaminate coming loose or physical contact (or near contact) between the elements. Replace it and the fuse with the proper slo-blo type and power up the amp using the power up procedure as we described earlier in this manual.

TUBE NOISE:

Often caused by contamination within in a tube, the culprit can usually be identified, and by lightly tapping on the glass, you will probably hear the noise change. Hearing some noise through the speakers while tapping on the 12AX7's is normal however. And the one nearer the INPUT will always sound louder because its output is being further amplified by the second 12AX7.

The power tubes should be all but quiet when they are tapped. If crackling or hissing changes with the tapping, you have probably found the problem. To confirm a noisy power tube, merely put the DC-3 on Standby, remove it from its socket and turn it back on. It will cause no damage to run the DC-3 briefly with one power tube missing. You may notice a slight background hum, however, as the push-pull becomes unbalanced. Whenever you are trying to diagnose a suspect tube, keep your other hand on the POWER and STANDBY switches ready to shut them off instantly in the unlikely case you provoke a major short.

If you think you've located a problem tube but aren't sure, we recommend substituting the suspect with a new one just to be sure of your diagnoses. You will be doing yourself and us a big favor by just following the simple guidelines previously mentioned regarding tube replacement. You'll probably be successful with much less effort than is required to disconnect everything and haul the unit to a technician who will basically perform the same simple tests. If the tubes are still within their six-month warranty period, we will happily send you a replacement. Just note the color designation on the tube label so that we can send you the appropriate match.

DIAGNOSING PRE-AMP TUBE PROBLEMS:

Because your amplifier is an all tube design, it is quite possible that you will at some point experience minor pre-amp tube noise. Rest assured - this is no cause for alarm and you can take care of the problem yourself in a matter of minutes by simply swapping tubes.

Let us begin by saying; It is a "very good" idea to keep at least a couple of spare pre-amp tubes on hand at all times to insure uninterrupted performance. These minor pre-amp tube problems can take many forms but can generally be described in two categories: Noise and Microphonics. Noise can be in the form of crackling, sputtering, white noise/hiss and/or hum. Microphonic problems usually appear in the form of a ringing or high pitched squealing that gets worse as the gain or volume is increased thus are more noticeable in the higher gain "HI" modes. Microphonic problems are easily identified because the problem is still present even with the instruments' volume off or unplugged altogether - unlike pick-up feedback which ceases as the instrument is turned down. Microphonic noise is caused by mechanical vibration and shock: think of banging a microphone around and you'll understand where the word came from.

The best way to approach a pre-amp tube problem is to see if it occurs only in one specific mode or channel. Then refer to the TUBE TASK CHART found on page 12 and it should lead you to the tube needing replacement. Then all that remains is to swap the suspect tube for a known good performer.

If you cannot narrow down the trouble to a specific mode or channel, the problem may be the small tube that drives the power tubes which is operational in all modes and channels. Though rare, a problem with the driver tube would show up in all aspects of performance - so if you can't narrow the problem down to being mode or channel specific, you may want to try replacing the driver tube. Driver problems generally show themselves in the form of crackling or hum in all modes of performance and/or weak overall output from the amplifier. Occasionally an anemic driver tube will cause the amplifier to sound flat and lifeless, but this is somewhat uncommon, as worn power tubes are a more likely suspect for this type of problem.

Sometimes making the diagnosis is more trouble than it's worth and it's faster and easier to merely replace the small pre-amp tubes ONE AT A TIME with a replacement known to be good. But MAKE SURE you keep returning the tubes to their original socket until you hit the one that cures the problem. You'll notice that tubes located nearer to the INPUT jack always sound noisier...but this is because they are at the start of the chain and their noise gets amplified over and over by the tubes that follow. The tube that goes into this "input socket" (usually labeled V1) needs to be the least noisy of the bunch. The tube that goes at the end of the preamp chain - just ahead of the power tubes - can be quite noisy without causing any problem at all. The tubes in your amp have already been located in the most appropriate sockets and this is why you should NEVER pull them all out at once and ALWAYS swap them one at a time. ALWAYS return a perfectly good tube to its original socket. Also it's a good idea to put the amp on STANDBY when swapping tubes to reduce the heat build up in the tubes themselves and to prevent explosive noises (which can still occur even if you are pulling the tubes away from their sockets gently) from coming through the speaker.

Remember, take your time, be patient and chances are real good that you can fix your amp yourself by finding and replacing the bad tube. It kills us to see someone who has shipped their amp back to us...and all it needed was a simple tube replacement! If you must send back your amp, unplug the power cord, speaker and reverb cables then remove the chassis from the cabinet by unscrewing the four mounting bolts on top. The chassis then slides back like a drawer and comes out. Remove the big power tubes and mark them according to their location from left to right 1, 2 etc. They need to be wrapped separately with plenty of wadded up newspaper around them and put in a smaller box within the larger carton. To wrap the chassis, use plenty of tightly wadded up newspaper so there is at least six inches of "crush space" between the chassis and the cardboard box. Bubble wrap also works well, but please DON'T use styrene peanuts - they will shift during transit and get lodged inside your electronics as well as allowing your amp to end up at the bottom of the box unprotected and possibly damaged. Pre-amp tubes don't normally wear out as a rule. Therefore, it is not a good idea to change them just for the sake of changing them. If there isn't a problem - don't fix it. If there is no result from your substitutions, it may be possible that you have more than one problematic tube. Though rare, this does happen and though it makes the troubleshooting process a little more intimidating, it is still possible to cure the problem yourself.

NOTE: It is normal to hear a slight metallic ringing sound when tapping on the preamp tubes. As long as the tube does not break into oscillation or start crackling or any other form of bizarre noise, it is considered normal and functional.

BIAS ADJUSTMENT: *(Part of a continuous series)*

Here's a question we often hear:

“Why doesn't Mesa put bias adjustments in their amplifiers?”

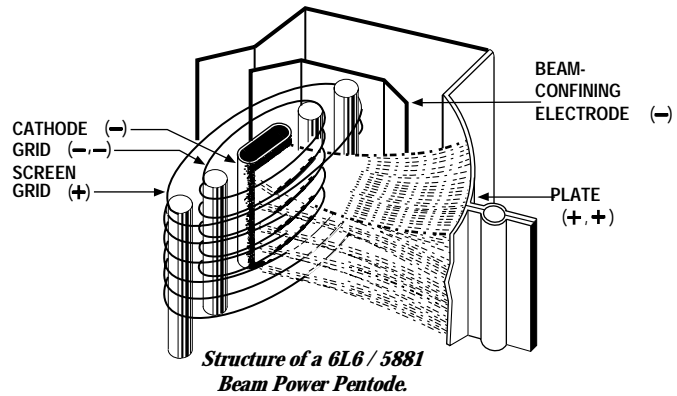

Well, there's a short answer and a long answer to this question.

The short answer is that during my 12 years of repairing Fenders, one of the most frequent problems I saw was bias controls that were either set wrong or that had wandered out of adjustment due to vibration. As any honest tech will tell you, there's lot's of easy money to be made by sprinkling “holy water” on amplifiers ... uh, what I meant to say is “Your amp needed biasing.” See what I mean? What customer is going to argue with that?

It only takes a moment and a volt meter: The Fender diagram shows how: “Adjust this trim pot for - 52 volts.” That's it. Nothing more.

Now don't be fooled into thinking that tubes “draw” more or less bias, they don't. The way a bias supply is connected to a tube is akin to a dead end road, it just trails off to nowhere without really completing a circuit. It's a static voltage and regardless of what tube is in the socket — or even if the tubes aren't plugged in at all, it doesn't change the bias voltage a bit.

So the end of the short answer is this: Since a bias supply needs to put out the right voltage and never vary, I wanted to build amplifiers that were individually hard wired to the correct values and NEVER needed adjustment. And for 25 years, that's how Mesa/Boogies have been built.

Time to change tubes? Just plug our tubes into any one of our amps and you're DONE. No tech needed. NO bills and no BS about biasing. And most important: The Bias is RIGHT because it can't change!

Now, you want the long answer? Here's more information on how our hard-wired bias avoids trouble. Please read on.

But first, let's make an important distinction. Our business is designing and building high performance amplifiers. And for this we need tubes whose variance is within a narrow range. Our warehouse is full of rejects ...oh, they work — they just don't perform within our tolerance range. We have a very sophisticated computer - based tube testing system (nicknamed “Robotube”) that matches and measures tubes over seven important parameters. It can even predict which tubes are likely to have a shortened lifetime — even though they work perfectly during the test.

Because our business is building quality amps, we can afford to reject a lot of wayward tubes. The guys you hear complaining because Boogies don't have bias adjusters are primarily in the business of selling tubes - not amps. They don't want to throw away 30 percent of their inventory, so they promote the idea that tubes outside our parameters can be used to “customize” amplifiers and they criticize us because our amps can't be adjusted to accommodate their out-of-Mesa tolerance tubes.

Now you might be thinking, “But I thought you just said that tubes don't “draw” bias, therefore they don't effect the bias supply and thus it doesn't need to be adjustable.”

When you set the bias (whether it's by selecting the right resistors, as we do, or adjusting a trimmer — which is quicker) what you are doing is establishing the correct amount of idle CURRENT that flows through the power tubes. But you can't adjust the current directly, you can only change it by adjusting the amount of bias VOLTAGE that goes onto the tubes' control grids.

BIAS ADJUSTMENT: *(Continued)*

Voltage and current are NOT the same. Current is the AMOUNT of electricity, the “quantity” — and is measured in amperes. Voltage is the degree of electric charge — like the “pressure” to use the old water analogy. Let me illustrate how different voltage and current are:

When you scrape your feet across a carpeted floor in dry, wintery conditions, your body can become charged with 50,000 to 100,000 volts of static electricity. And when you reach for the door knob, a spark jumps and you feel it! The voltage is super high but the current (measured in micro-amps) is tiny - otherwise you would die from electrocution.

Contrast this with your car battery, which puts out a mere 12 volts. You can lay your hands right across the terminals and not feel a thing. Yet the amount of current available can run to several hundred amperes .. enough to turn over a cold engine and get it started.

So current and voltage are two totally separate electrical parameters — though when you multiply them together, you get POWER, which is measured in watts.

When you set the bias of an amplifier, you are adjusting the static VOLTAGE at the control grid of the tube in order to produce a desired amount of idle CURRENT flowing to the tube's plate. A small change in grid voltage, produces a large change in the amount of current flowing — and that's basically how a tube works. Say that again because it's super important: A small change in voltage at the grid causes a large change in current flowing to the plate. See, that's the essence of amplification: A small change causing a large change. And here it's a small voltage change causing a large current change.

The bias conditions are what determines how much current flows through the big power tubes when you're not playing. And what drives your speakers is fluctuations in that current flow when ARE playing. If the amount of current increases and decreases 440 times per second, then you'll hear an A note. If the fluctuations in current flow are large and still at 440 per second, you'll hear an A that is LOUD!

But for purposes of biasing, it's the amount of “plate current” flowing with no signal applied that's important. Unfortunately current is hard to measure because the circuit must be interrupted — as in “cut the wire” — and the meter spliced “in series” with the broken circuit. But measuring VOLTAGE is easy. It is not necessary to interrupt the circuit because a voltage reading can be taken in PARALLEL with the circuit intact.

Thus, as a matter of convenience, most bias settings are given in volts at the grid ... even though current through the plate is the important factor. In fact plate current is so inconvenient (and dangerous) to measure that Fender doesn't even state what the correct value should be. They only give the grid voltage that will produce that current. (That's the minus 52.) But that only happens if the tubes being used are “in spec.”

As long as the tubes ARE “in spec”, the right bias voltage will always give the correct plate “CURRENT” — but then there's no need for the bias voltage to be adjustable!

If the tubes are NOT in spec, then the only proper way to re-set the bias is to cut the circuit and measure the current while adjusting the bias ... but no manufacturer I know even STATES the desired current value! Be that as it may, when the original bias voltage is altered far enough, it will compensate for the tube's abnormal performance and the correct amount of idle current flow may then be restored. Clearly this is something most repair techs should not attempt.

Some newer amps have LED indicators connected to the circuit which will turn on when the right threshold of current flow has been reached. This is an improvement, and almost worthy if you're willing to except resistors and lights added into your amplifier's audio path — which we aren't. The other “advantage” of this system is that it allows some amp manufacturers to avoid matching their power tubes. The thinking is that adjusting the bias to each tube separately eradicates the inherent differences between the tubes by insuring that the same current flows through each one.

Again, this has some merit .. but it's still not as good as using tubes that are matched in the first place because compensating for the mis-match causes the push-pull circuit itself to become unbalanced. Two wrongs don't really make a right.

BIAS ADJUSTMENT: *(Continued)*

Some of the other recommended biasing, “methods” — such as “.. tubes running red hot, increase the bias .. sounds harsh and runs too cool, turn it down ...” are guesswork at best. Luckily, one of the great things about tube amps is that they can usually stand some abuse without causing any real harm ... at least not immediately.

But don't these alterations imply that you are second-guessing the amp designer and that there's a better set of operating conditions that the designer missed but the tube sellers have discovered?

Now some players may like the sound of their amp altered by tubes with extreme characteristics and with the bias set to help compensate. But often it is the mere novelty of change that they're really responding to and when the amp goes back to the proper original way, we've seen them be far happier still!

Because every part in every one of our designs has been meticulously evaluated, compared and stressed over — no matter how seemingly insignificant it might be. And with every design we look for a “sweet spot” where all the parameters — including the bias — come together to give the best sonic performance, consistently and reliably. Every part and voltage is important — yet no one complains that these other parameters aren't available for tinkering.

Consider our patented Simul-Class circuitry where there are two different bias voltages used for separate pairs of power tubes ... and changing one voltage also changes the other. Great care goes into getting this just right and we think we'd be asking for trouble to have it adjustable for the world to play with ... unless you like paying to have your amp messed up. Sorry, I meant to say, “Uh, ... your amp needed biasing.”

If that doesn't appeal to you, then merely plug a matched set of Mesa tubes into one of our amps and you're ready for tone. Guaranteed. You'd be amazed at the number of service calls we field every day that lead to a diagnosis of out-of-tolerance, non-spec tube problems. To think these would be prevented by including a bias adjustment is something of an insult to you and us. If you put the wrong size tires on your car, do you think changing the pressure will make them right?

Please, don't think this is a blanket indictment of the other guys selling tubes — it isn't. And their tubes aren't all bad either. It just doesn't make sense to pay more of your hard earned cash for tubes that were probably made in the same Russian or Chinese factory and which have the possibility of being outside the performance window we select for your amp. And it pains us to hear the hype and mystique built up around biasing when twenty-five years of evidence affirms our decision to make bias circuits that “never need adjustment”. How much money and trouble that has saved Mesa/Boogie players you couldn't estimate.

Our rigorously tested and hand selected tubes are available at your nearest Mesa/Boogie Pro Center or from us directly. Nobody offers better price, quality or warranty than we do ... so why swerve?

Next time we'll talk about our part in developing the great Sylvania STR 415 type 6 6 and how we're on the verge of seeing something fairly close reappear on the market. Remember, we still have some of these super rugged mondo-bottles available for older amps — Boogies only please! Until then, Relax, Breathe and Nourish your soul!

Cheers!
Mesa/Boogie Ltd.

Randall Smith
Designer & President

FRONT VIEW DC-3

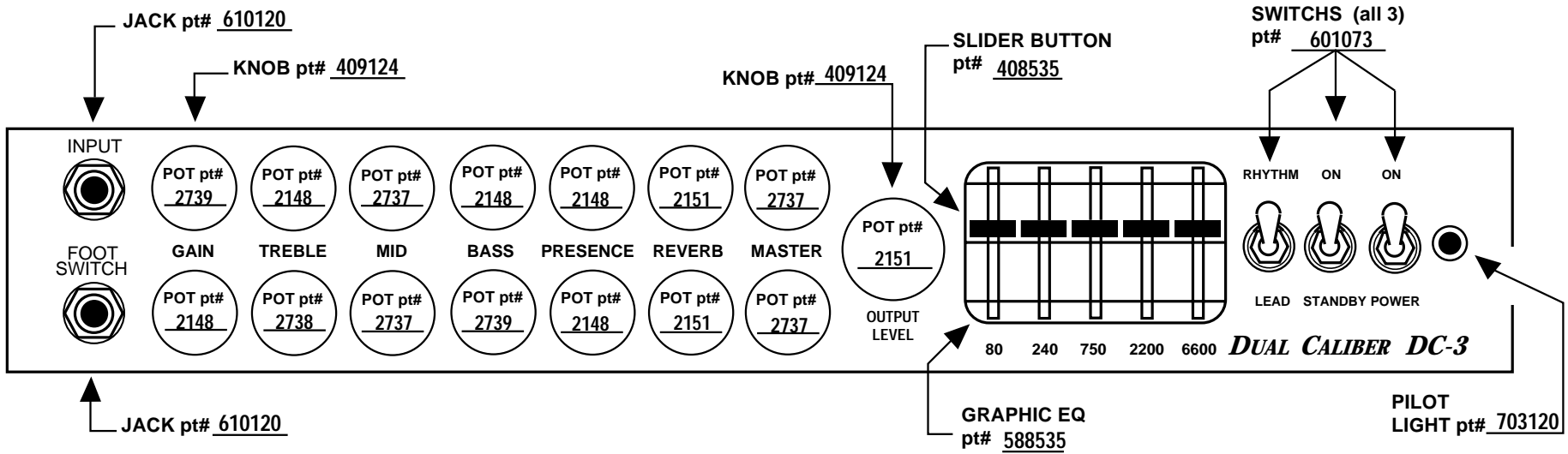

REAR VIEW DC-3

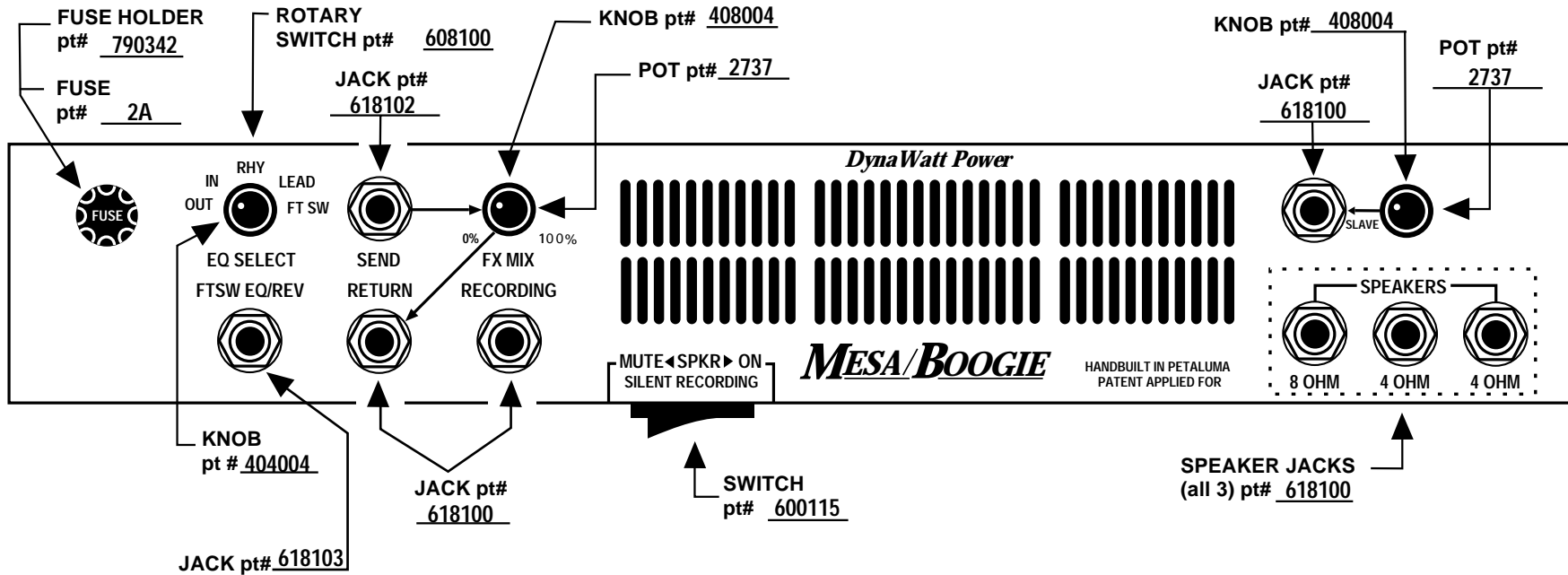

MESA/BOOGIE

The Spirit of Art in Technology

Thank you for trusting MESA/Boogie to be your amplifier company. We wish you many years of toneful enjoyment from this handbuilt all tube instrument.

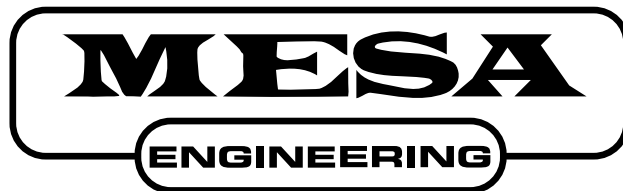

The Spirit of Art in Technology



(707) 778-6565 FAX NO. (707) 765-1503

1317 Ross Street Petaluma, CA 94954

USA